

# EMC/EMI line filter for lighting applications

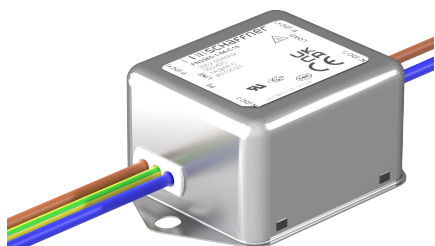

- Excellent EMC filter for lighting applications
- Choice between 3 different leakage ratings C00/C11/C16:
- -C00: no leakage current, medical applications
- -C11: low leakage current, safety applications
- -C16: standard version, best filter performance
- Voltage rating up to 300 VAC
- Choice between 4 current ratings: 1 A, 2 A, 5 A and 8 A
- Compact, space-saving design
- Cable outlets with enhanced length give freedom for flexible installation
- Versions without X-capacitor available - FN2564



### Performance indicators

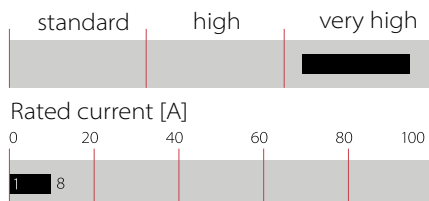

## Technical specifications

<b>Rated operating voltage</b>	300 VAC / 300 VDC
<b>Rated currents</b>	1 A, 2 A, 5 A and 8 A @ 60°C
<b>Operating frequency</b>	DC to 60 Hz
<b>Temperature range (operation and storage)</b>	-40°C to 100°C (40/100/21)*
<b>Climatic class</b>	40/100/21
<b>Cooling</b>	AN
<b>Flammability corresponding to</b>	Plastic material: UL-94V-0 Laces: UL94- VW1
<b>High potential test voltage</b>	P(DC+) → PE 3000 VDC for 2 sec P(DC+) → N(DC-) 1500 VDC for 2 sec
<b>Altitude</b>	2000m (above derating applies)*
<b>Certified to</b>	UL 60939-3, IEC/EN 60939-3, GB/T 15287
<b>Design corresponding to</b>	IEC 61347-1 - Lamp controlgear IEC 61547 - Equipment for general lighting purposes
<b>Protection category</b>	IP20
<b>Pollution degree</b>	2 acc. IEC 60664-1
<b>MTBF</b>	> 1.800.000 h
<b>Vibration and shock</b>	3M4 (operation); 2M2 (transport) acc. to IEC 60721-3-3; IEC 60721-3-2
<b>Overvoltage category</b>	III acc. IEC 60664-1
<b>Terminals</b>	Single strand solid wires AWG16 / AWG18

\* for dedicated requests exceeding this specification, please contact your local Schaffner sales office

### Approvals & Compliances



### Features and benefits

- Very high differential mode attenuation
- Suitable for AC and DC applications
- Offering a very high differential and common mode performance in low profile housing
- Easy installation with single strand wires
- Voltage rating according to high voltage LED lighting market

### Typical applications

- Lighting equipment
- LED driver and displays
- Street lamps and signage
- Industrial and architectural lighting
- Fluorescent ballasts
- Other applications with high demand for differential mode performance

### Typical electrical schematic - FN2560

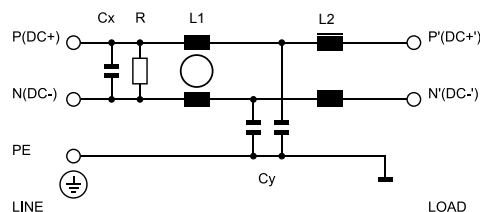

### Typical electrical schematic - FN2564 (no X-cap)

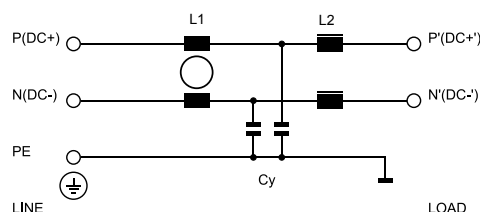

## Filter selection table

Filter	Rated current @ 60°C [A]	Leakage current* @ 300 VAC/60 Hz [mA]	Inductance**		Capacitance**		Dis. Resistor** R [kΩ]	Weight m [g]	Typ. Dissipation P [W]
			L1 [mH]	L2 [μH]	Cx [μF]	Cy [nF]			
<b>FN2560-1-04-C00</b>	1	0.0	4.0	198	0.470	-	1000	119	0.54
<b>FN2560-1-04-C11</b>	1	0.4	4.0	198	0.470	2 x 4.7	1000	119	0.54
<b>FN2560-1-04-C16</b>	1	3.1	4.0	198	0.470	2 x 33	1000	119	0.54
<b>FN2560-2-04-C00</b>	2	0.0	2.0	98	0.470	-	1000	125	1.52
<b>FN2560-2-04-C11</b>	2	0.4	2.0	98	0.470	2 x 4.7	1000	125	1.52
<b>FN2560-2-04-C16</b>	2	3.1	2.0	98	0.470	2 x 33	1000	125	1.52
<b>FN2560-5-04-C00</b>	5	0.0	1.0	51	0.470	-	1000	130	2.65
<b>FN2560-5-04-C11</b>	5	0.4	1.0	51	0.470	2 x 4.7	1000	130	2.65
<b>FN2560-5-04-C16</b>	5	3.1	1.0	51	0.470	2 x 33	1000	130	2.65
<b>FN2560-8-04-C00</b>	8	0.0	0.5	26	0.470	-	1000	135	3.45
<b>FN2560-8-04-C11</b>	8	0.4	0.5	26	0.470	2 x 4.7	1000	135	3.45
<b>FN2560-8-04-C16</b>	8	3.1	0.5	26	0.470	2 x 33	1000	135	3.45

\* Maximum leakage under usual AC operating conditions (acc. IEC 60939-3), calculated at 50Hz. If the neutral line is interrupted, worst case leakage could reach twice this level.

\*\* Tolerances apply: Inductance: -30/+50%, Capacitance: ±20%, Resistance: ±10%

## Performance adaptations available

Series for reduced reactive currents: FN2564

All FN2560 designations can also be ordered without X-capacitor. For example: FN2564-1-04-C00

- Pro: Lower reactive currents P (DC+) and N(DC-)
- Con: Lower differential mode attenuation performance

Options with adapted leakage currents (on request)

Additionally to the existing C00, C11 and C16 options, 10 other Y-capacitor options (0.47 - 22 nF) are available.

For FN2560 and FN2564 series

- Pro: Fine adaptation of leakage current between 0.00 mA and 3.11 mA
- Con: -

## Mechanical data

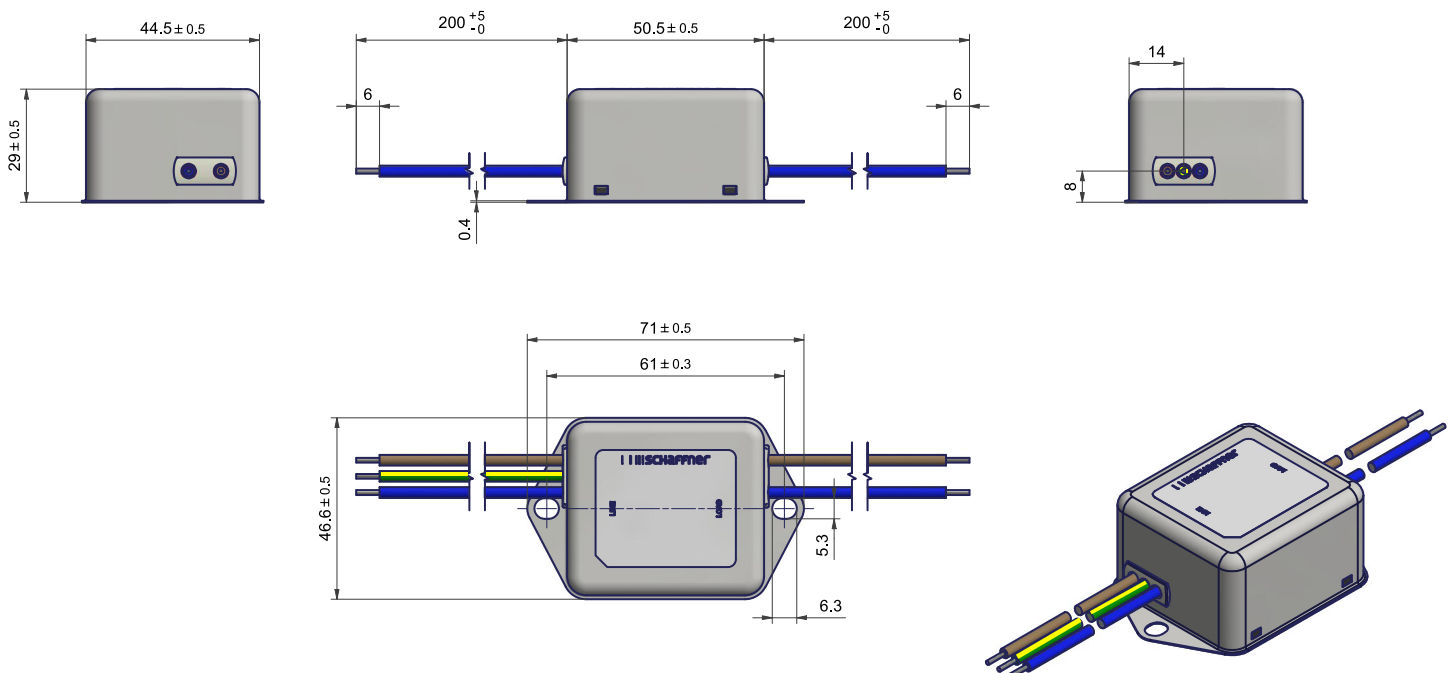

1 A - 5 A: Single strand solid wire 18 AWG

8 A: Single strand solid wire 16 AWG

All dimensions in mm; 1 inch = 25.4 mm Tolerances according: ISO 2768-m/EN 22768-m

### Typical filter attenuation

Per CISPR 17; DM=50 Ω/50 Ω sym, differential mode; CM=50 Ω/50 Ω asym, common mode

FN2560-1-04-C00 - no Y-Capacitor

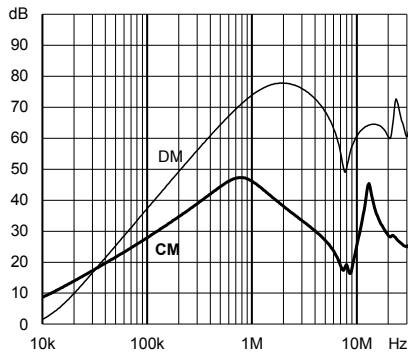

FN2560-1-04-C11 - 2 x 4.7 nF Y-Capacitor

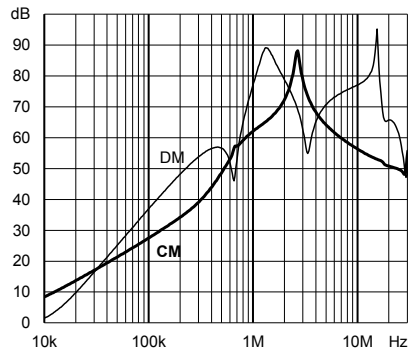

FN2560-1-04-C16 - 2 x 33 nF Y-Capacitor

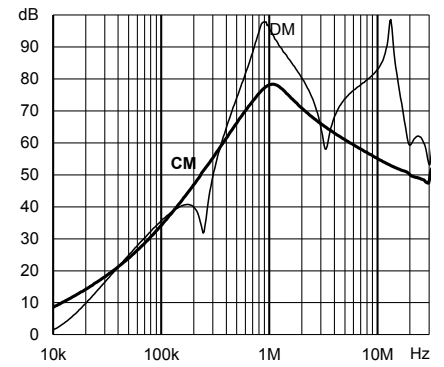

FN2560-2-04-C00 - no Y-Capacitor

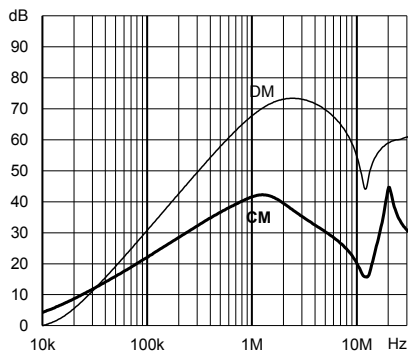

FN2560-2-04-C11 - 2 x 4.7 nF Y-Capacitor

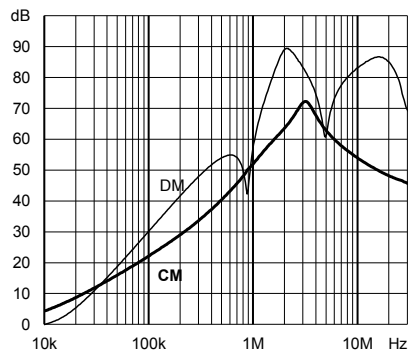

FN2560-2-04-C16 - 2 x 33 nF Y-Capacitor

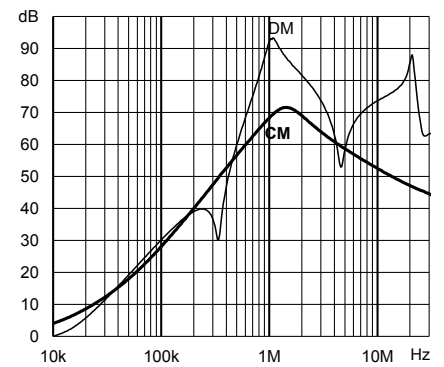

FN2560-5-04-C00 - no Y-Capacitor

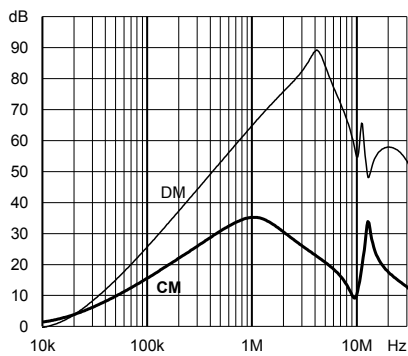

FN2560-5-04-C11 - 2 x 4.7 nF Y-Capacitor

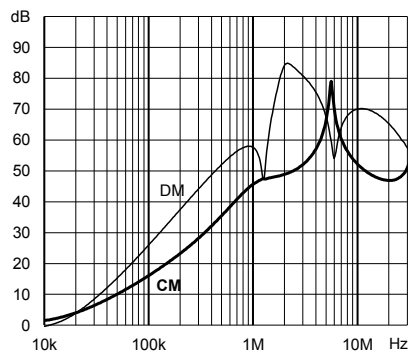

FN2560-5-04-C16 - 2 x 33 nF Y-Capacitor

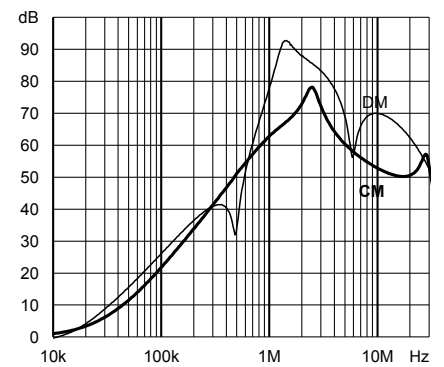

FN2560-8-04-C00 - no Y-Capacitor

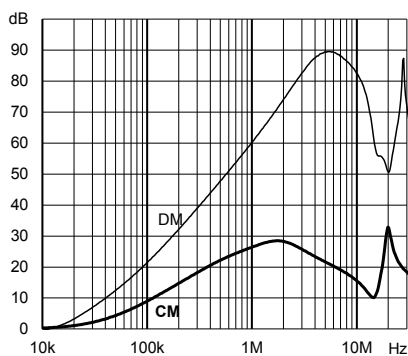

FN2560-8-04-C11 - 2 x 4.7 nF Y-Capacitor

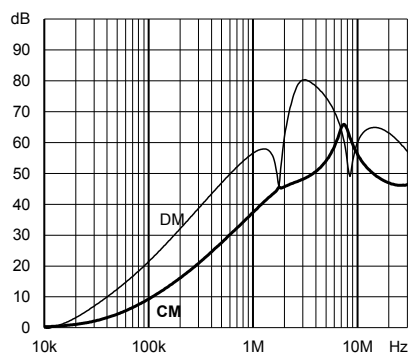

FN2560-8-04-C16 - 2 x 33 nF Y-Capacitor

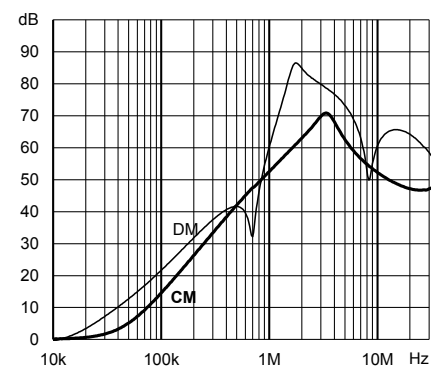



## Headquarters, global innovation and development

### Switzerland

#### Schaffner Group

Industrie Nord  
Nordstrasse 11e  
4542 Luterbach  
T +41 32 681 66 26  
[info@schaffner.com](mailto:info@schaffner.com)



## Sales and application centers

### China

#### Schaffner EMC Ltd. Shanghai

T20-3 C, No 565 Chuangye Road,  
Pudong district  
201201 Shanghai  
T +86 21 3813 9500  
[cschina@schaffner.com](mailto:cschina@schaffner.com)  
[www.schaffner.com.cn](http://www.schaffner.com.cn)

### Finland

#### Schaffner Oy

Sauvonrinne 19 H  
08500 Lohja  
T +358 50 468 7284  
[finlandsales@schaffner.com](mailto:finlandsales@schaffner.com)

### France

#### Schaffner EMC S.A.S.

16-20 Rue Louis Rameau  
95875 Bezons  
T +33 1 34 34 30 60  
F +33 1 39 47 02 28  
[francesales@schaffner.com](mailto:francesales@schaffner.com)

### Germany

#### Schaffner Deutschland GmbH

Schoemperlenstrasse 12B  
76185 Karlsruhe  
T +49 721 56910  
F +49 721 569110  
[germanysales@schaffner.com](mailto:germanysales@schaffner.com)

### India

#### Schaffner India Pvt. Ltd

REGUS WORLD TRADE CENTRE  
WTC, 22nd Floor Unit No 2238, Brigade  
Gateway Campus, 26/1, Dr. Rajkumar Road  
Malleshwaram (W)  
560055 Bangalore  
T +91 80 67935355  
[indiasales@schaffner.com](mailto:indiasales@schaffner.com)

### Italy

#### Schaffner EMC S.r.l.

Via Ticino, 30  
20900 Monza (MB)  
T +39 039 21 41 070  
[italysales@schaffner.com](mailto:italysales@schaffner.com)

### Japan

#### Schaffner EMC K.K.

Taiju-Seimei Sangenjaya Bldg.  
1-32-12, Kamiyama, Setagaya-ku  
154-0011 Tokyo  
T +81 3 5712 3650  
F +81 3 5712 3651  
[japansales@schaffner.com](mailto:japansales@schaffner.com)  
[www.schaffner.jp](http://www.schaffner.jp)

### Singapore

#### Schaffner EMC Pte Ltd.

#05-09, Kg Ubi Ind. Estate  
408705 Singapore  
T +65 6377 3283  
F +65 6377 3281  
[singaporesales@schaffner.com](mailto:singaporesales@schaffner.com)

### Spain

#### Schaffner EMC España

Calle Caléndula 93, Miniparc III, Edificio E  
El Soto de Moraleja, Alcobendas  
28109 Madrid  
T +34 917 912 900  
F +34 917 912 901  
[spainsales@schaffner.com](mailto:spainsales@schaffner.com)

### Sweden

#### Schaffner EMC AB

Östermalmstorg 1  
114 42 Stockholm  
T +46 8 5050 2425  
[swedensales@schaffner.com](mailto:swedensales@schaffner.com)  
[www.schaffner.com](http://www.schaffner.com)

### Switzerland

#### Schaffner EMV AG

Industrie Nord  
Nordstrasse 11e  
4542 Luterbach  
T +41 32 681 66 88  
T +41 32 681 66 26  
[switzerlandsales@schaffner.com](mailto:switzerlandsales@schaffner.com)

### Taiwan

#### Schaffner EMV Ltd.

20 Floor-2, No 97, Section 1, XinTai 5th Road  
22175 XiZhi District New Taipei City 22175  
T +886 2 2697 5500  
F +886 2 2697 5533  
[taiwansales@schaffner.com](mailto:taiwansales@schaffner.com)  
[www.schaffner.com.tw](http://www.schaffner.com.tw)

### Thailand

#### Schaffner EMC Co. Ltd.

Northern Region Industrial Estate  
67 Moo 4 Tambon Ban Klang  
Amphur Muangng P.O. Box 14  
51000 Lamphun  
T +66 53 58 11 04  
F +66 53 58 10 19  
[thailandsales@schaffner.com](mailto:thailandsales@schaffner.com)

### United Kingdom

#### Schaffner Ltd.

1, Oakmede Place  
Binfield  
RG42 4JF Berkshire  
T +44 118 9770070  
F +44 118 9792969  
[uksales@schaffner.com](mailto:uksales@schaffner.com)

### USA

#### Schaffner EMC Inc.

52 Mayfield Avenue  
Edison, New Jersey  
T +1 732 225 9533  
F +1 732 225 4789  
[usasales@schaffner.com](mailto:usasales@schaffner.com)  
[www.schaffnerusa.com](http://www.schaffnerusa.com)

To find your local partner within Schaffner's global network: [www.schaffner.com](http://www.schaffner.com)

© 2020 Schaffner Group

The content of this document has been carefully checked and understood. However, neither Schaffner nor its subsidiaries assume any liability whatsoever for any errors or inaccuracies of this document and the consequences thereof. Published specifications are subject to change without notice. Product suitability for any area of application must ultimately be determined by the customer. In all cases, products must never be operated outside their published specifications. Schaffner does not guarantee the availability of all published products. This disclaimer shall be governed by substantive Swiss law and resulting disputes shall be settled by the courts at the place of business of Schaffner Holding AG. Latest publications and a complete disclaimer can be downloaded from the Schaffner website. All trademarks recognized.